

Programmable Safety Controllers

G9SP



Compact Stand-Alone Programmable Controller

- Stand-alone safety controller for small and mid-sized machinery
- Easy programming for complex safety control
- Three types of CPU with different I/O size to suit the application
- Four types of Expansion I/O Units for hard-wired diagnosis or standard signals
- Clear diagnosis and monitoring via Ethernet or Serial connection
- Supports direct connection with non-contact switches and safety mats
- Easy design, verification, standardization and reusage of safety control by unique programming software
- ISO 13849-1(PLe), IEC61508(SIL3) certified



Example of System Configuration

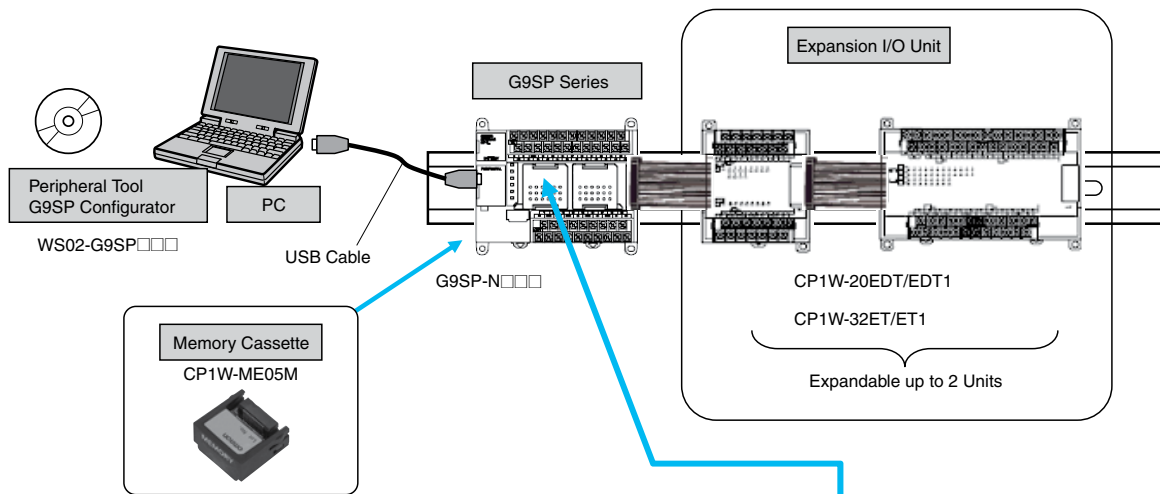

When the Units are distantly-positioned such as one above the other layout

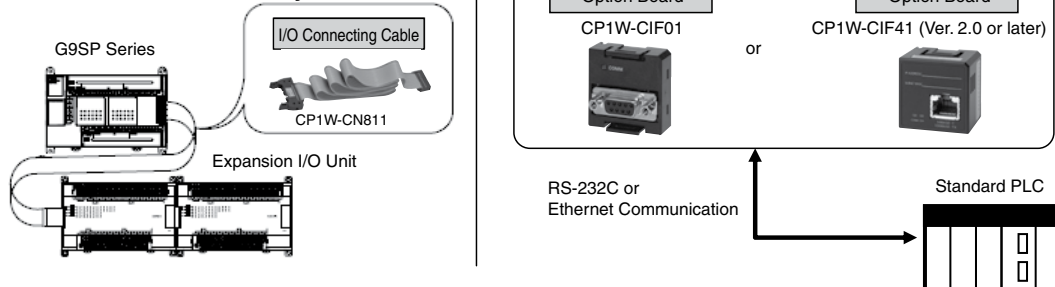

J

Specifications

G9SP Series

General Specifications

Power supply voltage	24 VDC (20.4 to 26.4 VDC -15% +10%)
Current consumption*	G9SP-N10S: 400 mA (V1: 300 mA, V2: 100 mA) G9SP-N10D: 500 mA (V1: 300 mA, V2: 200 mA) G9SP-N20S: 500 mA (V1: 400 mA, V2: 100 mA)
Isolation class	Class III (SELV)
Overvoltage category	II
Noise immunity	Conforms to IEC61131-2
Vibration resistance	5 to 8.4 Hz: 3.5 mm, 8.4 to 150 Hz: 9.8 m/s ²
Shock resistance	147 m/s ² : 11 ms
Mounting	DIN track mounting (IEC60715 TH35-7.5/TH35-15) or M4 screws
Ambient operating temperature	0 to +55°C
Ambient operating humidity	10% to 90% (with no condensation)
Ambient storage temperature	-20°C to +75°C
Atmosphere	No corrosive gas
Degree of protection	IP20 except terminal blocks
Terminal screws	M3 self-rising screws

*Not including the current consumption of external devices.

	G9SP-N10S	G9SP-N10D	G9SP-N20S
Safety inputs	10	10	20
Safety outputs	4	16	8
Test outputs	4	6	6
Standard outputs	4	—	—
Weight	290 g max.	440 g max.	430 g max.

Safety Input Specifications

Input type	Sinking inputs (PNP)
Input current	6 mA
ON voltage	11 VDC min. (between each input terminal and G1)
OFF voltage	5 VDC max. (between each input terminal and G1)
OFF current	1 mA max.

Test Output Specifications

Output type	Sourcing outputs (PNP)
Rated Output Current	G9SP-N10S
	T0, T1 : 60 mA max.
	T2 : 30 mA max. *1
	T3 : 300 mA max. *2
	T0-2 total : 60 mA max.
	G9SP-N10D
	T0, T1, T2 : 60 mA max.
	T3 : 300 mA max. *2
	T4, T5 : 30 mA max. *1
	Total of T0-2 and T4-5 : 60 mA max.
	G9SP-N20S
	T0, T1, T2 : 100 mA max.
T3 : 300 mA max. *2	
T4, T5 : 30 mA max. *1	
Total of T0-2 and T4-5 : 120 mA max.	

*1 Connection to OMRON D40A Non-contact Door Switch is possible.

*2 With the Muting Lamp Output (open circuit detection)

Safety Output Specifications

Output type	Sourcing outputs (PNP)
Rated output current	0.8 A max./output 1.6 A max./4 outputs (G9SP-N10S/-N20) *1 1.2 A max./4 outputs (G9SP-N10D) *2
ON residual voltage	1.2 V max. (between each output terminal and V2)
OFF residual voltage	2 V max.
Leakage current	0.1 mA max.

*1. Total current for So0 to So3 and So4 to So7

*2. Total current for So0 to So3, So4 to So7, So8 to So11 and So12 to So15

Note: When a safety output is set as a pulse output, make sure that the connected devices do not malfunction due to the OFF pulse (pulse width: 640 μs).

Standard Output Specifications (G9SP-N10S)

Output type	Sourcing outputs (PNP)
ON residual voltage	1.5 V max. (between each output terminal and V2)
Rated output current	100 mA max.

Specifications (continued)

Configurator

General Specifications

Applicable PC	DOS/V PC (Refer to the attached file for the operating environment of G9SP tool.)	
CD-ROM or DVD-ROM drive	One or more	
Applicable OS	Windows 2000 (Service Pack 3 or later), Windows XP (Service Pack 2 or later)	Windows Vista (Except for 64 bit version)
CPU processing speed	Pentium II 333 MHz or faster (Pentium III 1GHz or faster is recommended.)	Pentium III 1GHz or faster is recommended.
Memory (RAM)	256 MB min. (512 MB or more is recommended.)	512 MB min. (1 Gbyte or more is recommended.)
Hard disk	200 MB or more	
Monitor	High-intensity display of SVGA (800 x 600) or more Required min. 256 colors display	
Communication port to connect with G9SP Series	USB 1.1	

Certified Standards

Certification body	Standard
TÜV Rheinland	EN ISO 13849-1: 2008 EN ISO 13849-2: 2008 IEC 61508 parts 1-7: 2010 IEC/EN 62061: 2005 IEC 61131-2: 2007 EN ISO 13850: 2008 (EN418: 1992) EN 60204-1: 2006 EN 61000-6-2: 2005 EN 61000-6-4: 2007 NFPA 79-2007 ANSI RIA 15.06-1999 ANSI B11.19-2003 UL1998
UL	UL508 CSA22.2 No.142

J

Specifications (continued)

Expansion I/O Unit

Input Specifications (CP1W-20EDT/20EDT1)

Input voltage	24 VDC, -15% +10%
Input impedance	4.7 kΩ
Input current	5 mA TYP
ON voltage	14.4 VDC min.
OFF voltage	5.0 VDC max.
ON delay	1 ms max. *
OFF delay	1 ms max. *
Circuit configuration	

*ON/OFF delay represents the hardware delay time.

Output Specifications (Transistor outputs: sinking/sourcing type)

	CP1W-20EDT/EDT1	CP1W-32ET/32ET1
Maximum switching capacity *1	24 VDC -5% +10% 0.3 A/output 0.9 A/common 1.8 A/unit	4.5 to 30 VDC 0.3 A/output 0.9 A/common 7.2 A/unit
Leakage current	0.1 mA max.	0.1 mA max.
Residual voltage	1.5 V max.	1.5 V max.
ON delay	0.1 ms max.	0.1 ms max.
OFF delay	1 ms max. 24 VDC, -5% +10%, when 5 to 300 mA	1 ms max. 24 VDC, -5% +10%, when 5 to 300 mA
Maximum number of outputs for simultaneous ON	8 outputs (100% load)	24 outputs (75% load)
Fuse *2	1/common	1/common
Circuit configuration	Sinking type (CP1W-20EDT, CP1W-32ET) 	Sourcing type (CP1W-20EDT1, CP1W-32ET1)

*1. A maximum of 0.9 A per common can be switched at an ambient temperature of 50°C.

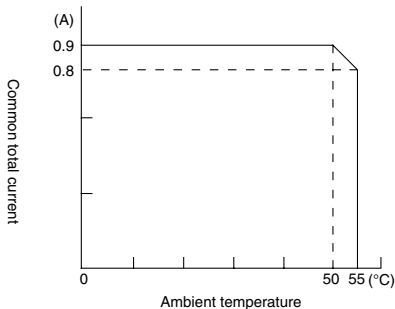

*2. User cannot replace fuses. Replace the unit if a fuse blows due to short circuit, etc.

Specifications (continued)

Option Unit RS-232C Option Board (CP1W-CIF01)

Communication Specifications

Connection method	D-SUB 9P (female)
Maximum transmission distance	15 m
Communication protocol	Non-procedural
Maximum data length	Refer to the Users Manual for details.

Ethernet Option Board (CP1W-CIF41 unit ver. 2.0 or later)

Ethernet Communication Specifications











Name		CP Series Ethernet Option Board		
Model		CP1W-CIF41		
Type		100 BASE-TX (applicable as a 10 BASE-T)		
Transmission specifications	Media access method	CSMA/CD		
	Modulation method	Baseband		
	Transmission path type	Star form		
	Baud rate	100 Mbps (100 BASE-TX)	10 Mbps (10 BASE-T)	
		Internal transmission speed between G9SP and Ethernet Option Board is of 115.2 kbps.		
	Transmission media	Unshielded twisted-pair (UDP) cable Categories: 5, 5e Shielded twisted-pair (STP) cable Categories: 100 Ω at 5, 5e	Unshielded twisted-pair (UDP) cable Categories: 3, 4, 5, 5e Shielded twisted-pair (STP) cable Categories: 100 Ω at 3, 4, 5, 5e	
	Transmission distance	100 m (distance between hub and node)		
Number of cascade-connectable units	No limit when a switching hub is used.			
Weight		23 g max.		
Dimensions		36.4 (W) x 36.4 (H) x 28.2 (D) mm		

J

Functions







Function Blocks

Logic Functions

Function Block Name	Notation on Function List	Icon	Details
NOT	NOT		Outputs the logical complement of the input condition.
AND	AND		Outputs the logical AND of the input conditions.
OR	OR		Outputs the logical OR of the input conditions.
NAND	NAND		Outputs the logical NAND of the input conditions.
NOR	NOR		Outputs the logical NOR of the input conditions.
Exclusive OR	EXOR		Outputs the exclusive OR of the input conditions.
Exclusive NOR	EXNOR		Outputs the exclusive NOR of the input conditions.
RS-FF (Reset Set Flip-Flop)	RS-FF		When the input signal turns ON, RS-FF holds the ON status in the function block and continuously connects to the output.
Comparator	Comparator		Compares the input signals to the set value and turns ON the output if they match.
Comparator 2	Comparator2		Compares the input signals to the set value and outputs the comparison result.













J

Timer/Counter Functions



Function Block Name	Notation on Function List	Icon	Details
Off-Delay Timer	Off-Delay Timer		Operates an OFF-delay timer.
On-Delay Timer	On-Delay Timer		Operates an ON-delay timer.
Pulse Generator	Pulse Generator		Cyclically outputs ON/OFF pulses on the Output Enable while the input signal is ON.
Counter	Counter		Counts the number of input signals and turns ON the output when the count reaches the specified number.
Up-Down Counter	Up-Down Counter		Increments the counter on the leading edge of an up count input and decrements the counter on the leading edge of a down count input.
Serial-Parallel Converter	Serial-Parallel Converter		Counts the number of input signals and outputs the count value.

Functions (continued)



Safety Device Function Blocks

Function Block Name	Notation on Function List	Icon	Details
External Device Monitoring	EDM		Evaluates the input signal and external device status and sends a safety output to the external device. This function block is used to detect fused contacts or external wiring problems (disconnected lines) for safety relays, contactors, and other safety devices.
Enable Switch Monitoring	Enable Switch	 Enable	Monitors the status of an Enable Switch device.
Emergency Stop Switch Monitoring	E-Stop		Monitors the status of an Emergency Stop Switch.
Light Curtain Monitoring	Light Curtain Monitoring		Monitors the input signal from a Safety Light Curtain.
Muting	Muting	 Mute	Temporarily disables the input signals for a Light Curtain when the muting signal is detected.
Safety Gate Monitoring	Safety Gate Monitoring		Monitors the status of a safety door (Safety-door Switch or Safety Limit Switch). This function block can be used to set function tests for Safety Category 2.
Two Hand Controller	Two Hand Controller		Monitors the status of a Two-hand Switch.
User Mode Switch Monitoring	User Mode Switch		Monitors the operating mode switch for a user system or device.
Redundant Input Monitoring	Redundant Input		Monitors for discrepancies in two input signals.
Single Beam Safety Sensor	Single Beam Safety Sensor		Monitors the input signal of an OMRON E3ZS/E3FS Single-beam Safety Sensor.
Non-Contact Door Switch Monitoring	Non-Contact Door Switch		Monitors an Omron STI D40A Non-contact Door Switch.
Safety Mat Monitoring	Safety Mat		Monitors an Omron STI UM Safety Mat.

Reset and Restart Function Blocks

Function Block Name	Notation on Function List	Icon	Details
Reset	Reset	 RESET	Outputs ON if the reset signal is correctly input while the input condition is ON. This function block can be used to prevent equipment from starting automatically.
Restart	Restart	 Restart	Performs the same operation as a Reset function block. The icon is different.

Connector Function Blocks

Function Block Name	Notation on Function List	Icon	Details
Multi Connector	Multi Connector		Outputs the status of the input signals.
Routing	Routing		Distributes an input signal to multiple signals.

Wiring

Terminal Arrangement

G9SP-N10S

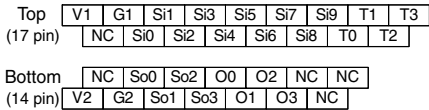

G9SP-N10D

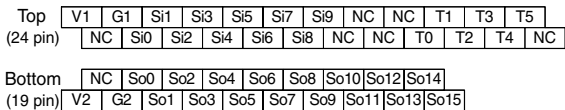

G9SP-N20S

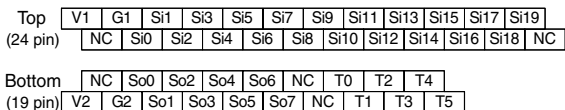

Terminals	Function
V1/G1	Power supply terminals for Internal/Input circuits (24 VDC)
V2/G2	Power supply terminals for output circuits (24 VDC)
NC	Not used (Do not connect.)
Si0 - Si19	Safety input terminals
T0 - T5	Test output terminals
So0 - So15	Safety output terminals
O0 - O3	Standard output terminals

Internal Circuits and Wiring Example

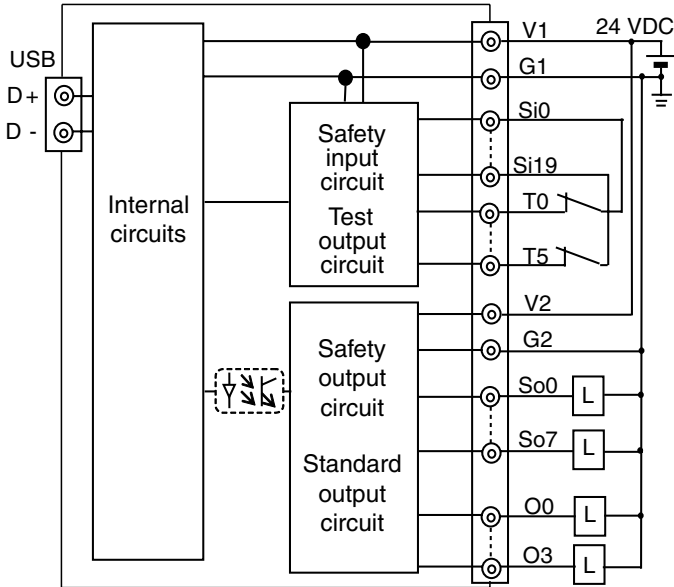

I/O Wiring Example: Emergency Stop (Dual Channel) with Manual Reset

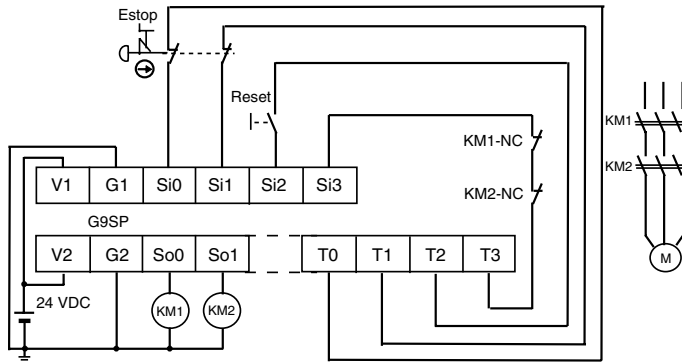

Dimensions

(mm)

Safety Controller

G9SP-N10S

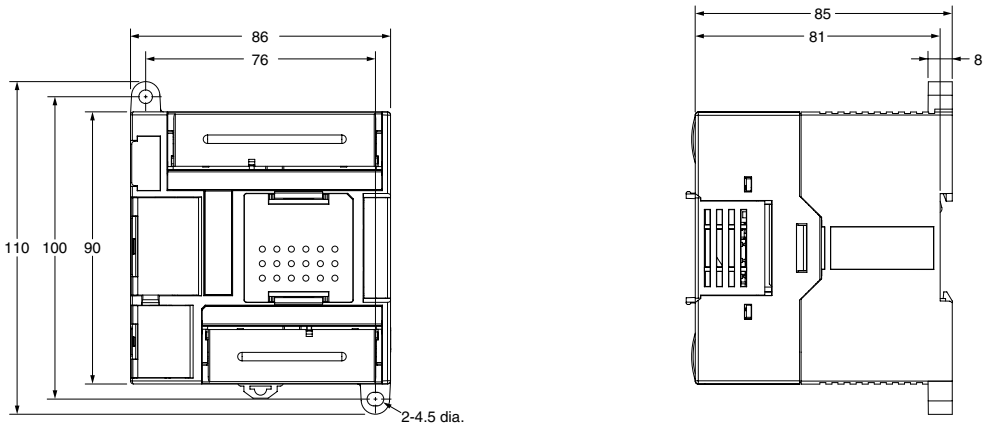

Safety Controller

G9SP-N10D

G9SP-N20S

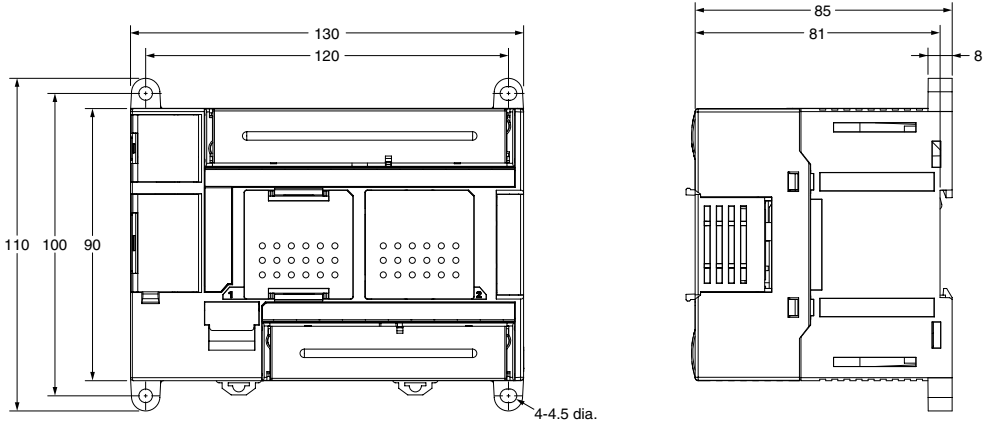

Ordering

G9SP Series

Name	Number of I/O				Unit version	Model
	Safety inputs	Test outputs	Safety outputs	Standard outputs		
Safety Controller	10	4	Solid-state outputs: 4	4	Ver.1.0	G9SP-N10S
	10	6	Solid-state outputs: 16	—		G9SP-N10D
	20	6	Solid-state outputs: 8	—		G9SP-N20S

Expansion I/O Unit (for standard machine control)

Name	Type	Number of I/O		Model
		Inputs	Outputs	
Expansion I/O Unit	Sinking type	12	Solid-state outputs: 8	CP1W-20EDT
	Sourcing type			CP1W-20EDT1
	Sinking type	—	Solid-state outputs: 32	CP1W-32ET
	Sourcing type			CP1W-32ET1

Note: CP1W-CN811 I/O Connecting Cable is available.
Refer to the Catalog of CP1H/CP1L Programmable Controller (Cat. No. P057-E1) for details.

I/O Connecting Cable

Name	Specifications	Model
I/O Connecting Cable	80 cm (for the distantly-positioned units connection)	CP1W-CN811

Note: An I/O Connecting Cable (approx. 6 cm) for alongside setting is included in the Expansion I/O Unit package.

J

Option Unit

Name	Model
RS-232C Option Board	CP1W-CIF01
Ethernet Option Board (Unit Ver. 2.0 or later)	CP1W-CIF41
Memory Cassette	CP1W-ME05M

Note: Refer to the Catalog of CP1H/CP1L Programmable Controller (Cat. No. P057-E1) for details.

Configurator

Name	Media	Applicable OS	Model
G9SP Configurator	Setup Disk (CD-ROM: 1 license)	Windows 2000 (Service Pack 3 or advanced) Windows XP Windows Vista (Except for 64bit version)	WS02-G9SP01-V1
	Setup Disk (CD-ROM: 10 licenses)		WS02-G9SP10-V1
	Setup Disk (CD-ROM: 50 licenses)		WS02-G9SP50-V1
	Setup Disk (CD-ROM: Site license)		WS02-G9SPXX-V1